



Score 
Cut 



Shaft Spacers



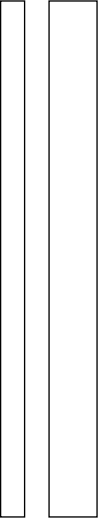
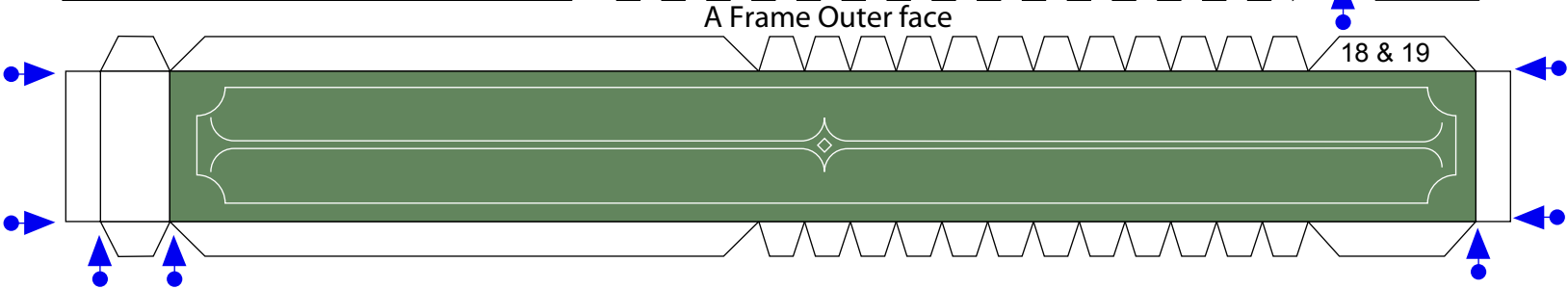
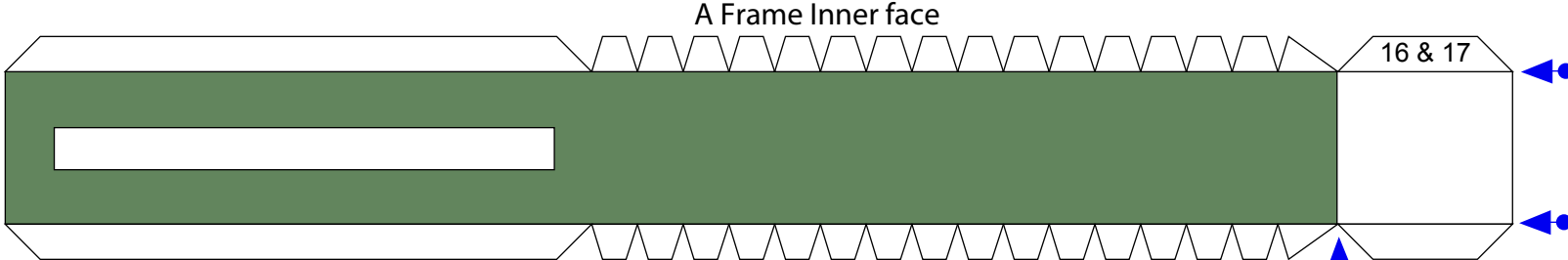
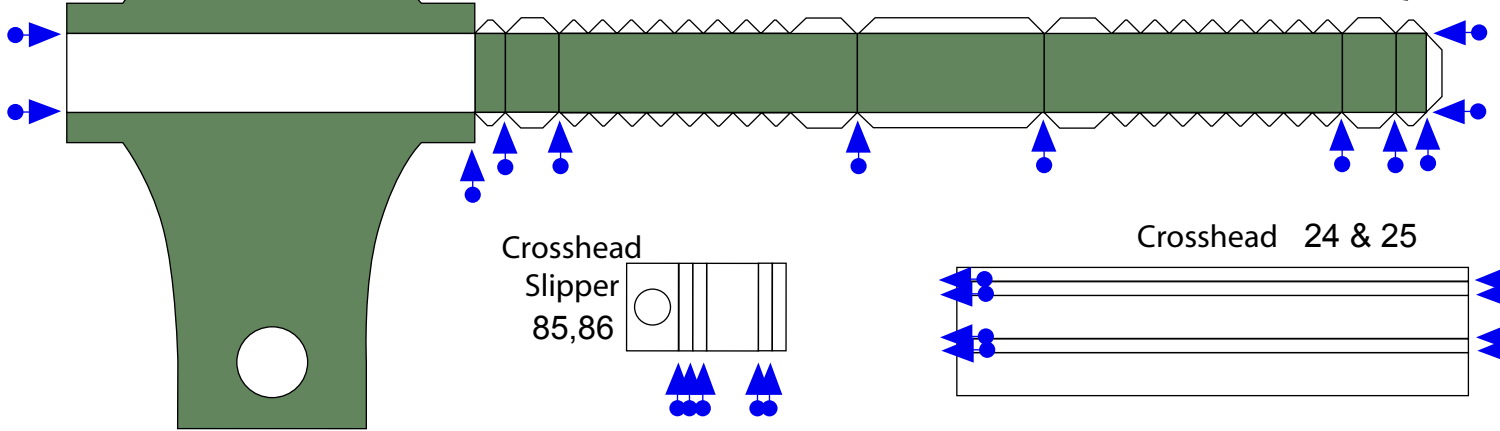
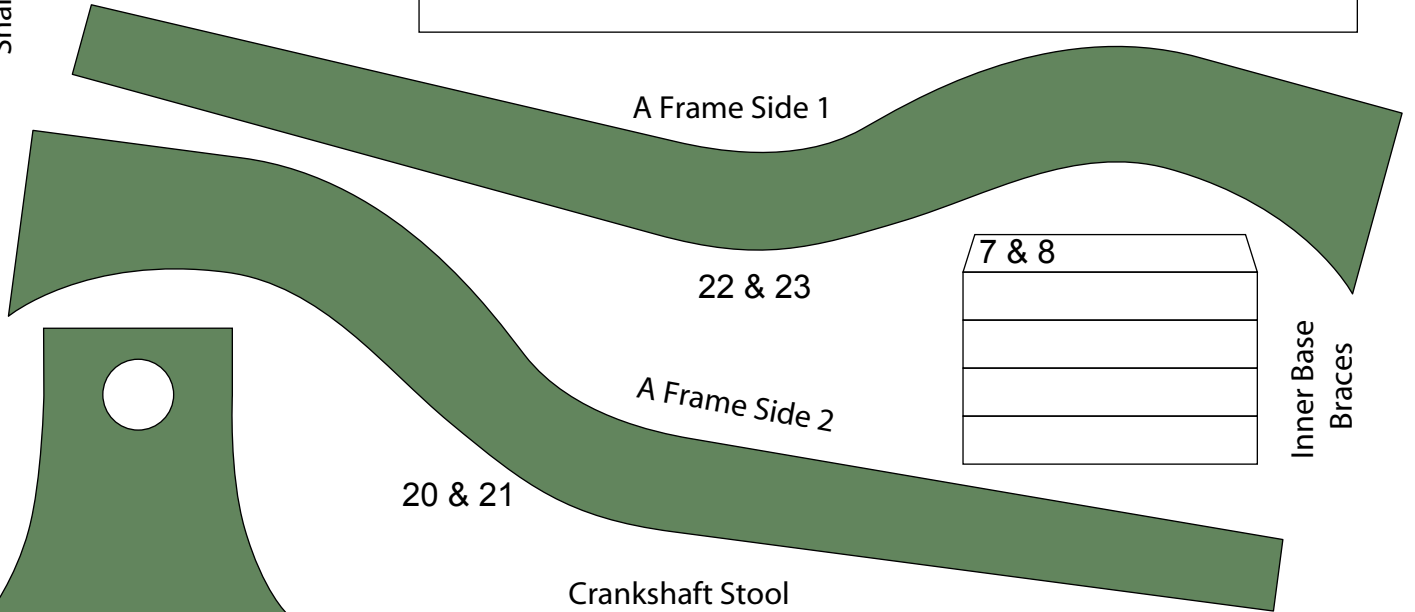
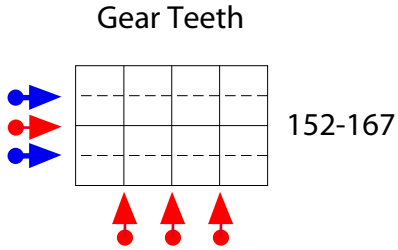
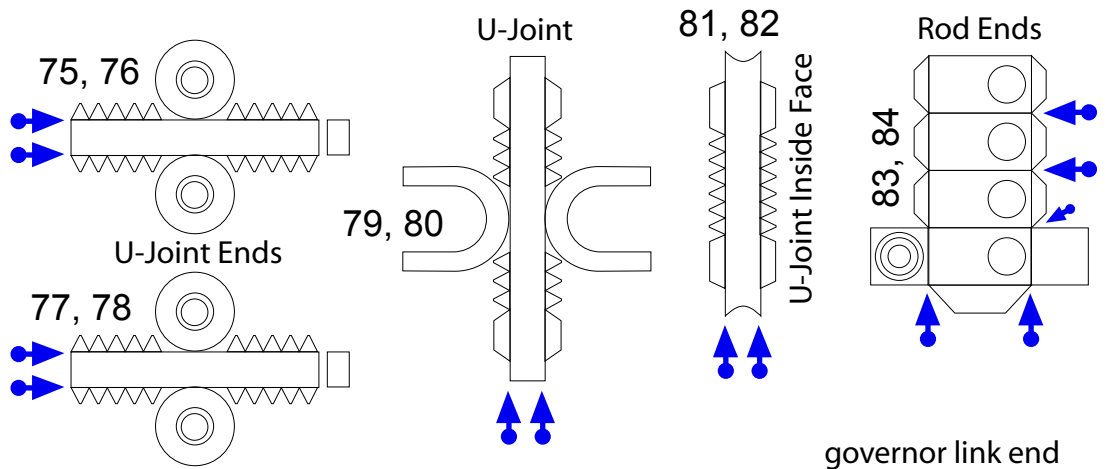
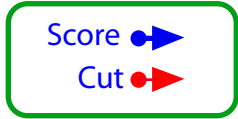

39 & 40

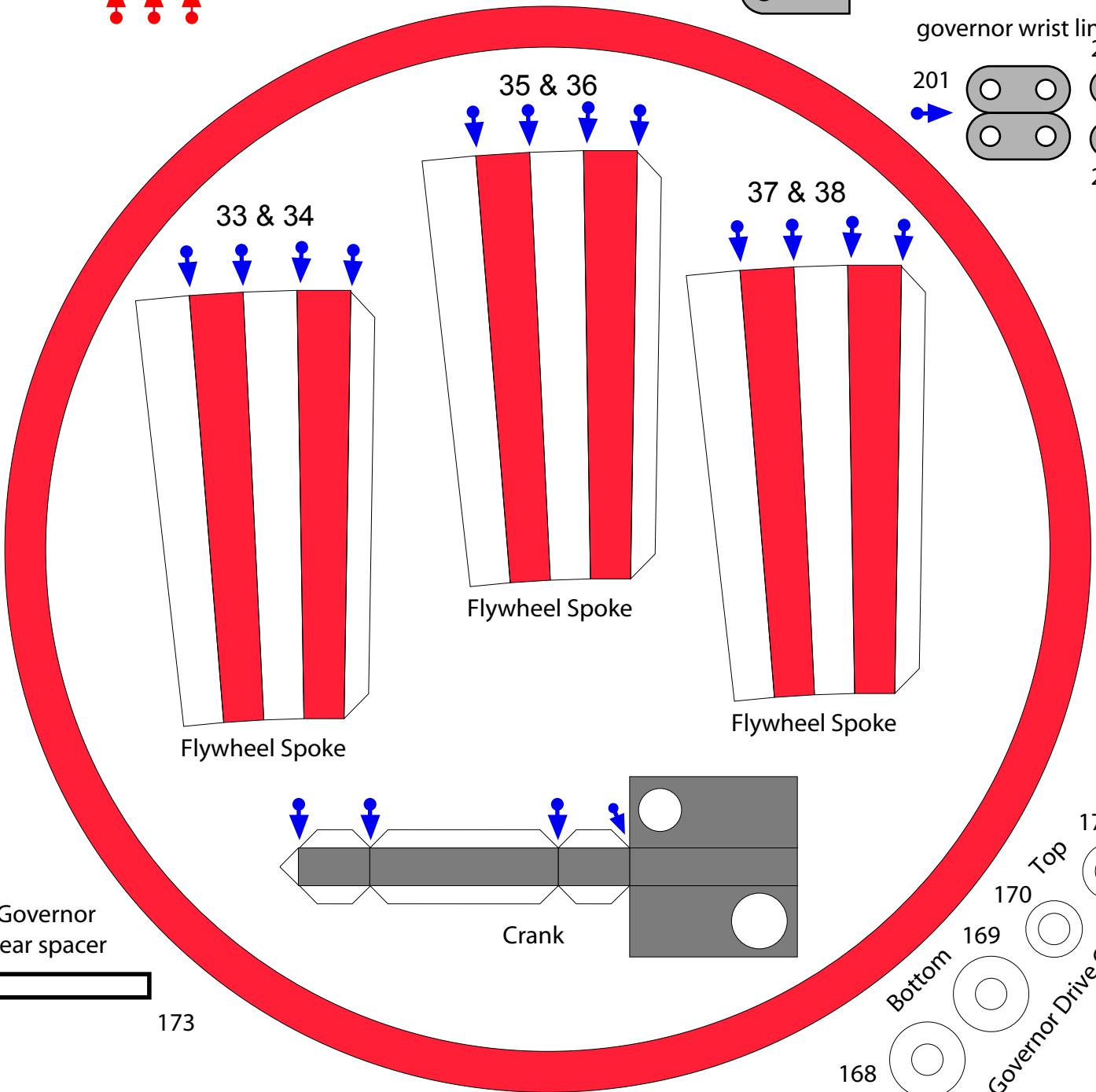
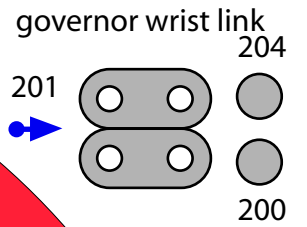
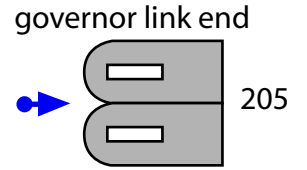
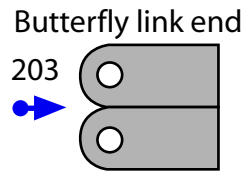

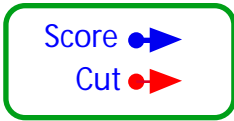

Governor Follower Arm

Pin Head
177

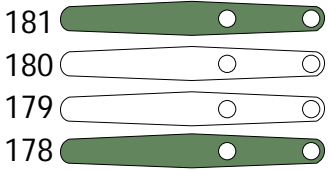

Outer Flywheel

Pin Head
186

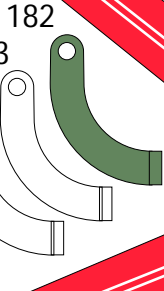

Governor Follower Arm Mount

Governor Pin Mounts

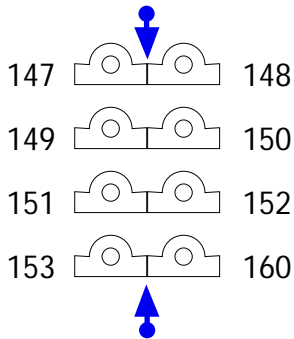

Governor Follower Arm Rider

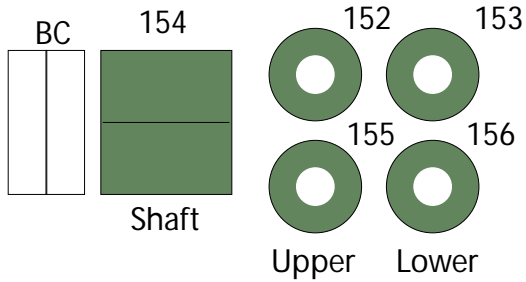

Governor Flyball Subassembly Mounts

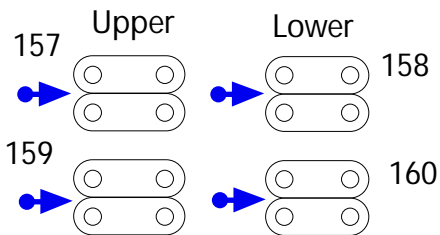

41

Governor Follower Arm Mount Base

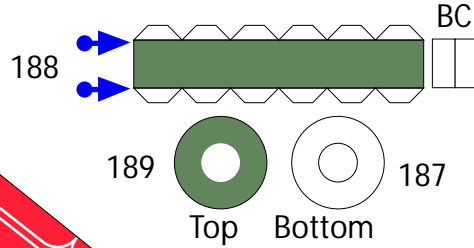

Inner Flywheel

42

Boiler Feed Pump Housing

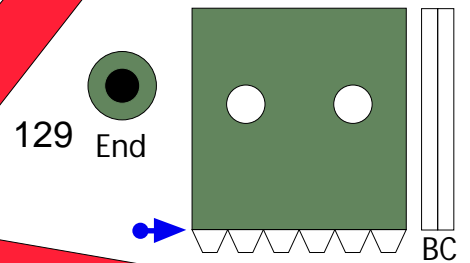

Boiler Feed Pump Vertical Mount

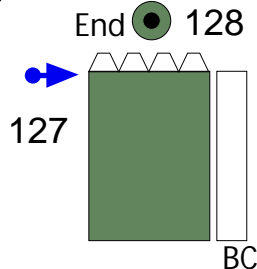

Cap End

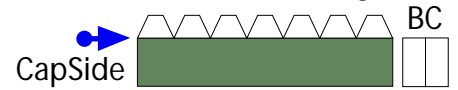

CapSide

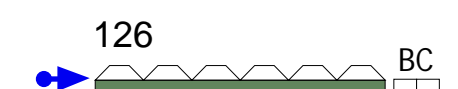

Base



Boiler Feed Pump

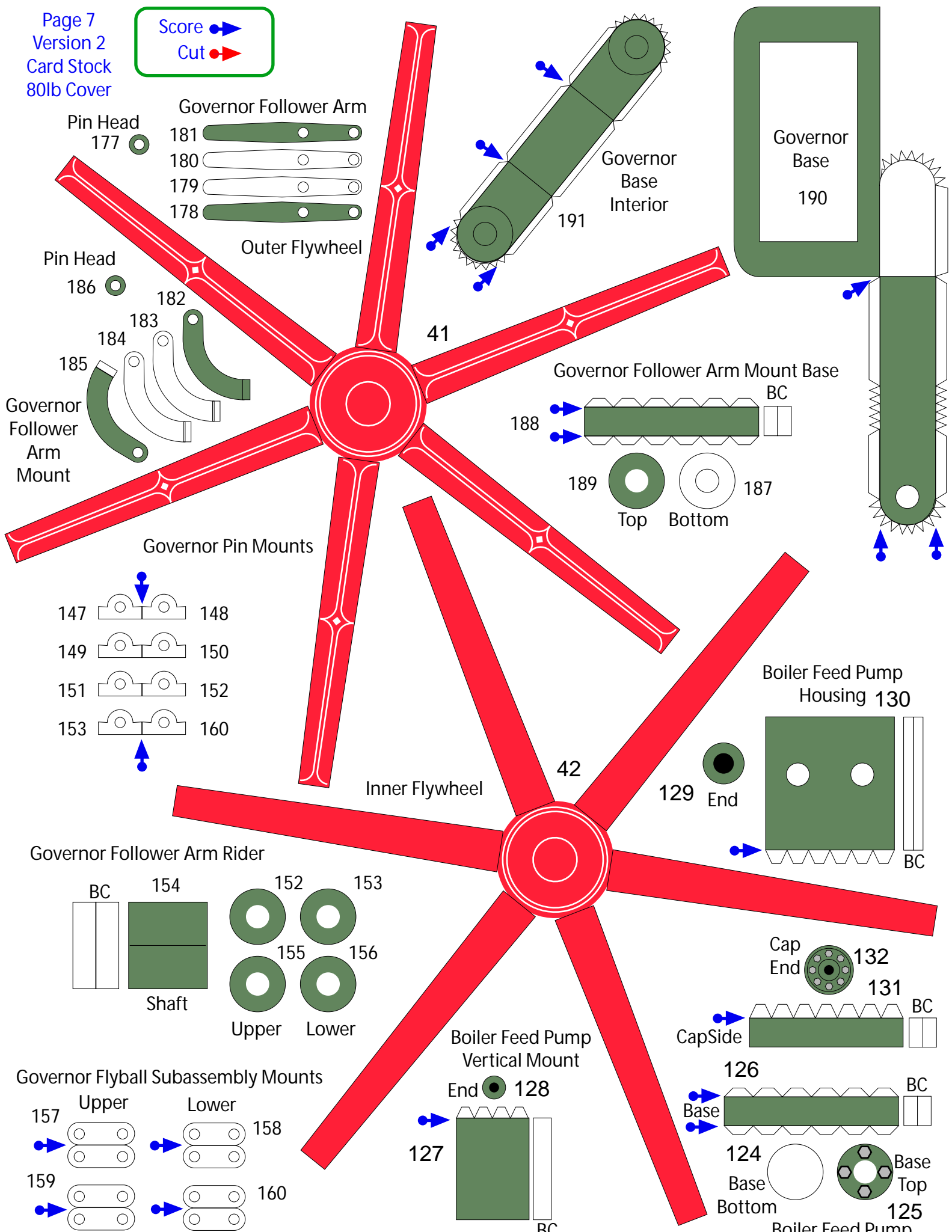
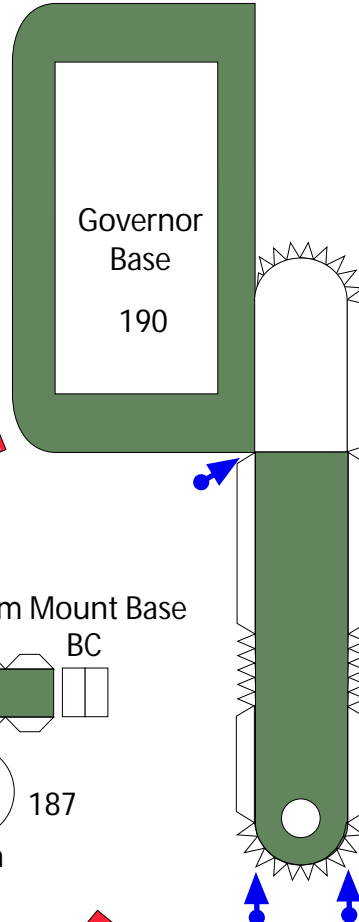

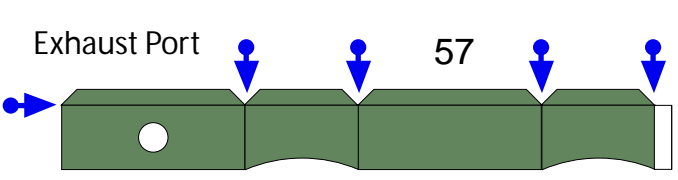

Exhaust Port Base
210

Page 8 Version 2
Print On Card Stock

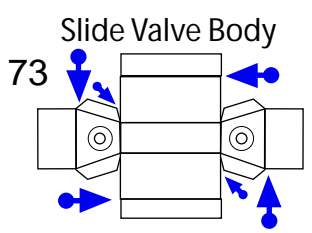

Valve Chest Gland Face

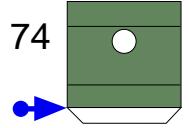

Valve Chest

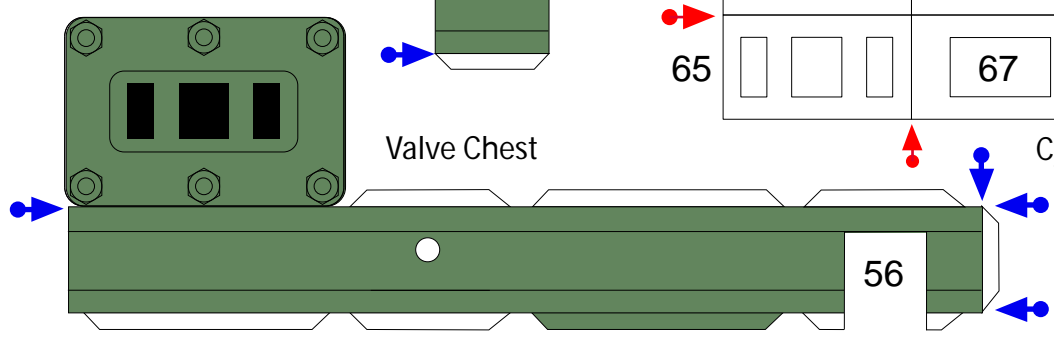

Valve Plate	
60	72
61	71
62	70
63	69
64	68
65	67

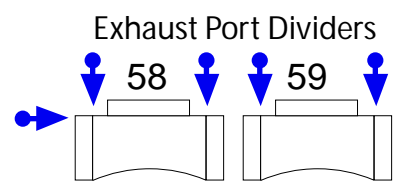

Valve Chest Top Face

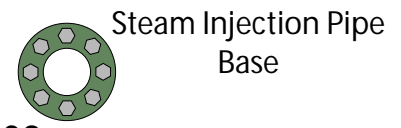
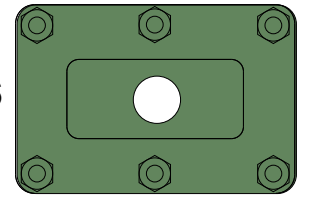

Cylinder Top

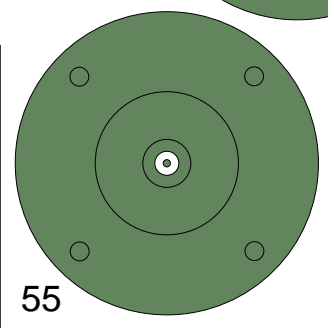
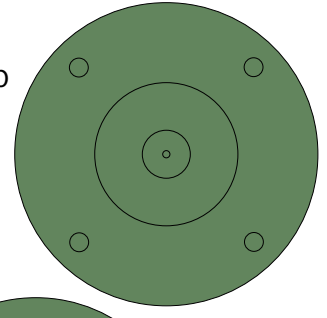

Cylinder Bottom Outside

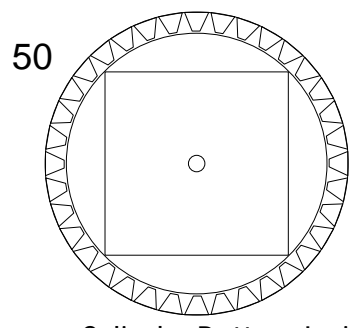

Cylinder Bottom Inside

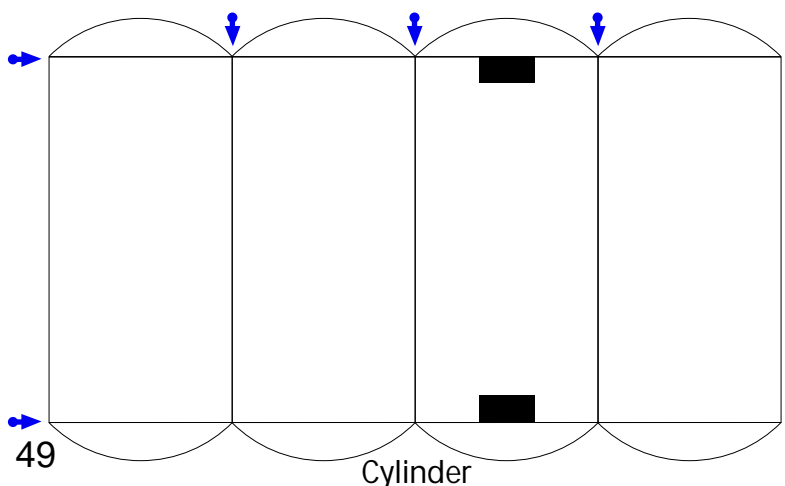
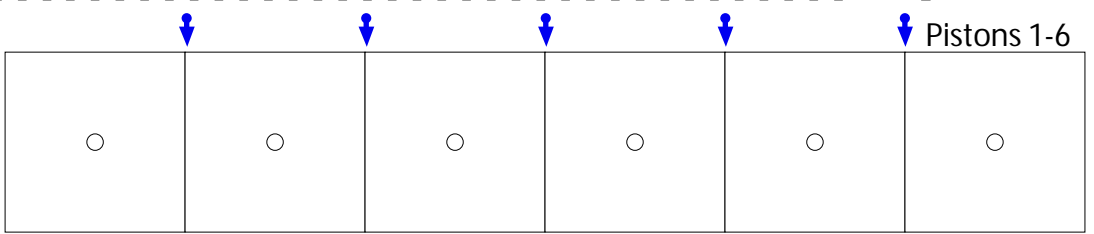

Steam Port 1

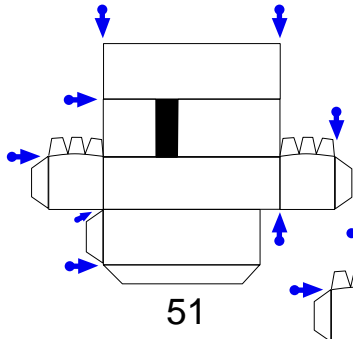

Steam Port 2

